

LA-301 User's Guide

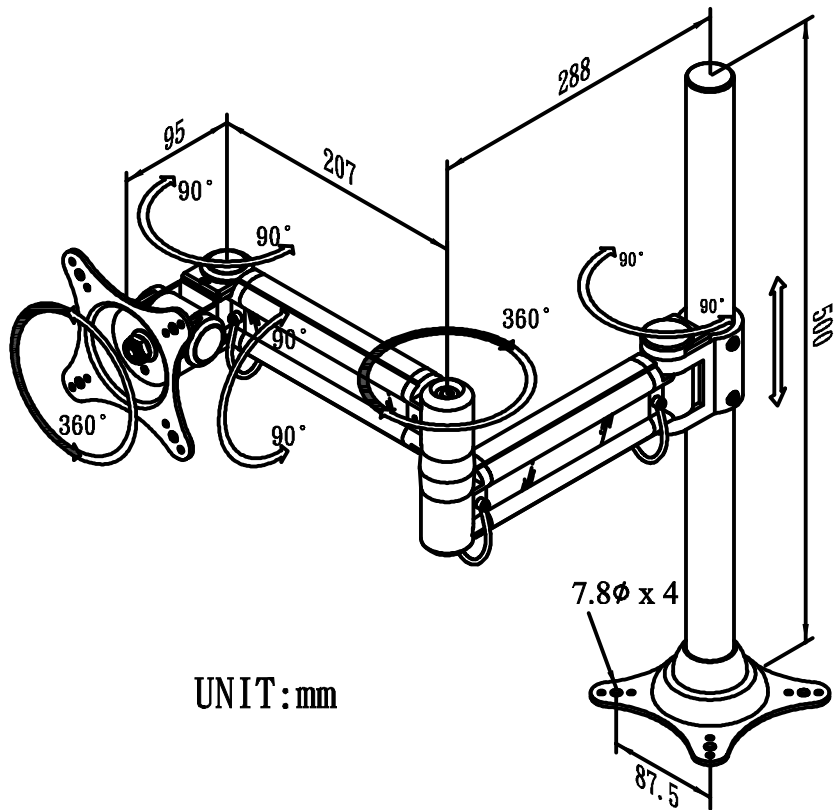

Notice :

The adjustment of the screw has been made before out of the factory. Loosening the screw will cause the stand bent downwards. Please note if the monitor will be hit.

