

LA-102 User's Guide

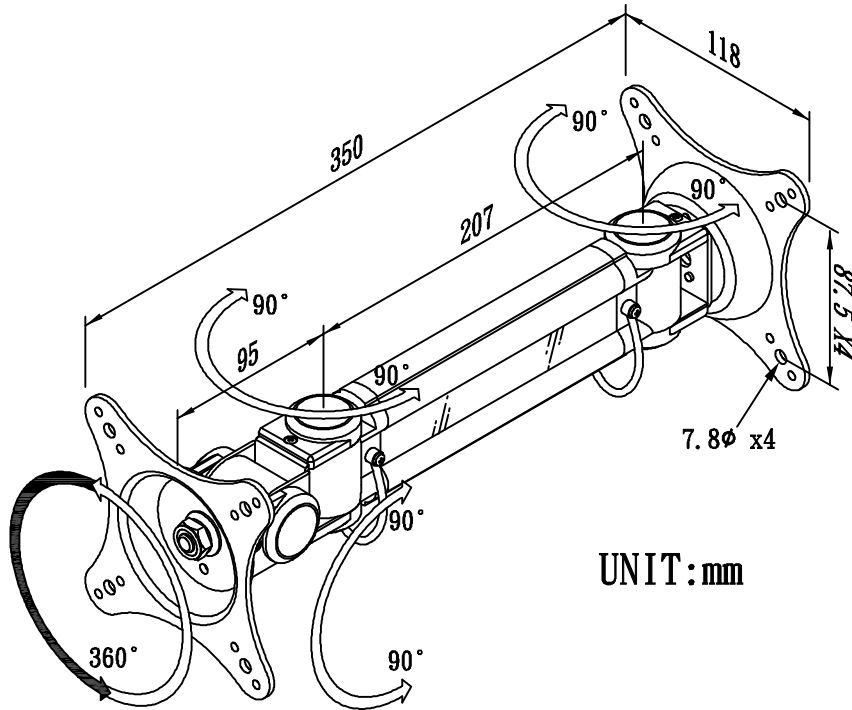

UNIT: mm

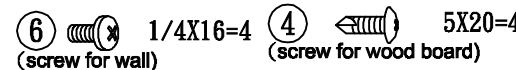
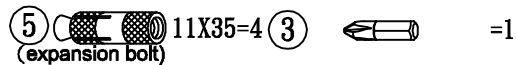

Notice :

The adjustment of the screw has been made before out of the factory.

Loosening the screw will cause the stand bent downwards.

Please note if the monitor will be hit.

