

LA-101 User's Guide

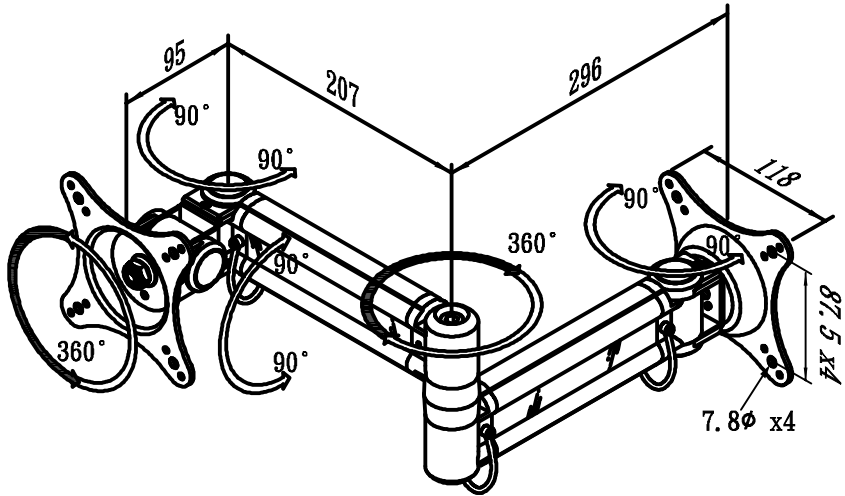

UNIT: mm

Notice :

The adjustment of the screw has been made before out of the factory.

Loosening the screw will cause the stand bent downwards. Please note if the monitor will be hit.

